

Electrical Wiring

F.1	Electrical Wiring	
F.2	Spare parts	
	Power board	
	Control board	

code

RT-5102-EM

model

ROTARY

power

ELECTRIC

instrumentation

ELECTROMECHANICAL

details

WITH "ELIWELL" TIMER
SINGLE-PHASE EXTRACTOR
WITH PROXIMITY
WITH HOOK OR PLATFORM

operating voltage

230-400 Vac

auxiliary voltage

24 Vac

frequency

50-60 Hz

CE

revision

R-0

creation date

30/08/2016

revision date

30/08/2016

design

DF

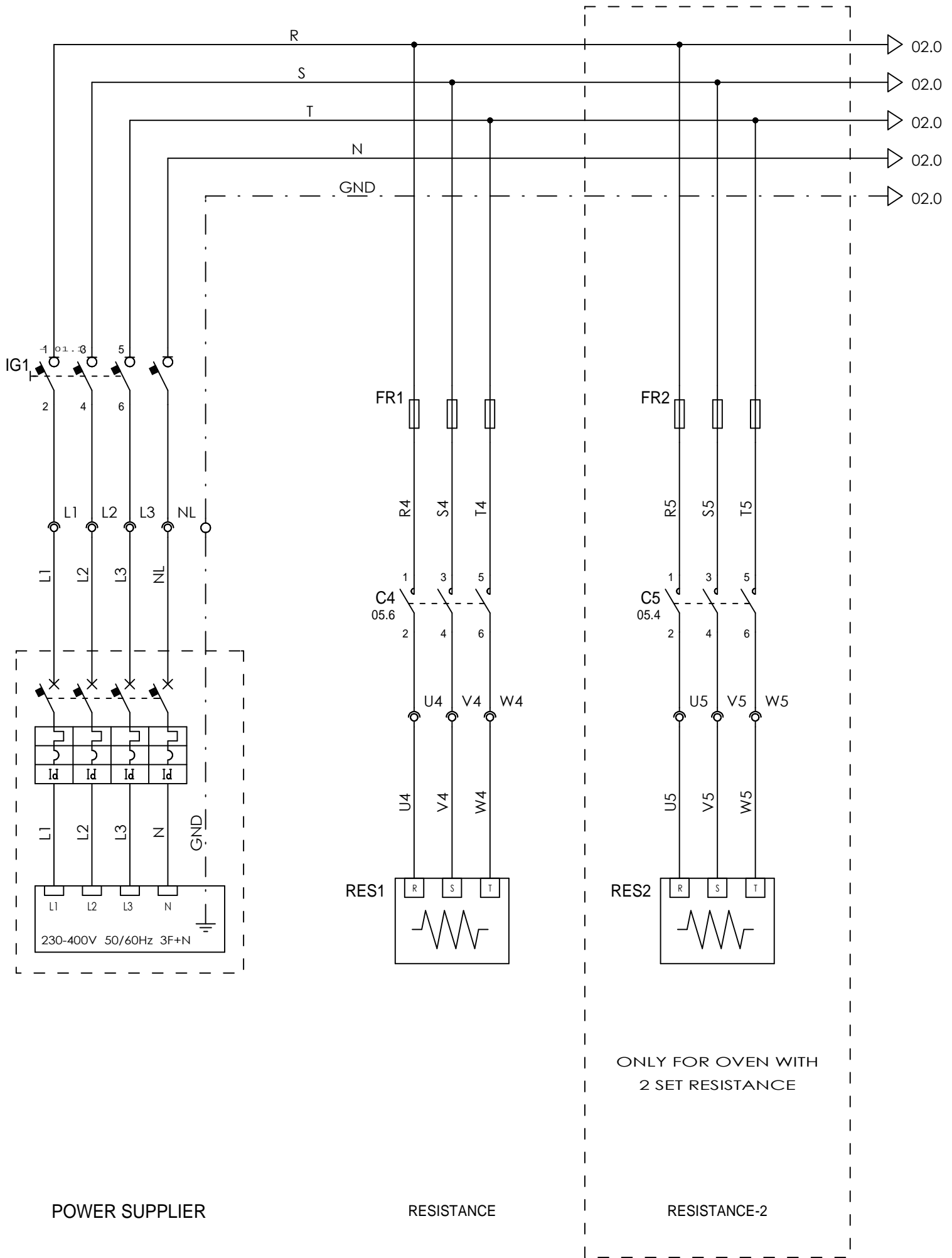

ONLY FOR OVEN WITH
2 SET RESISTANCE

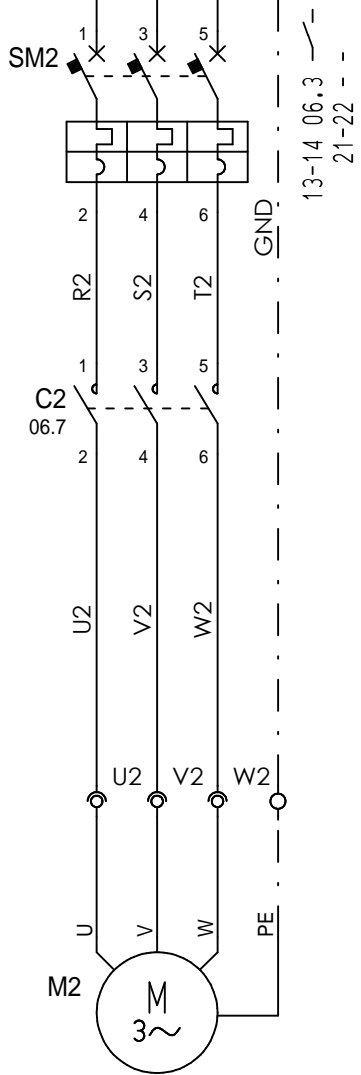
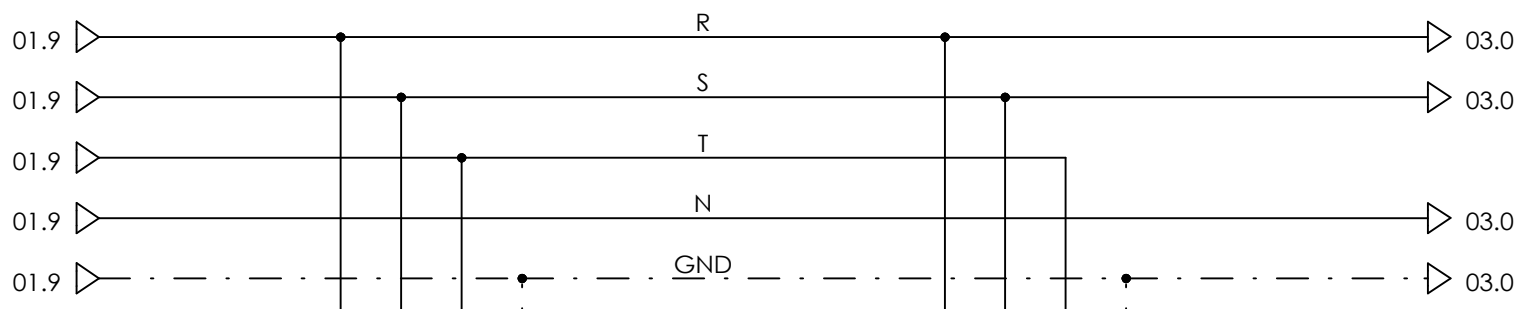

BLOWER

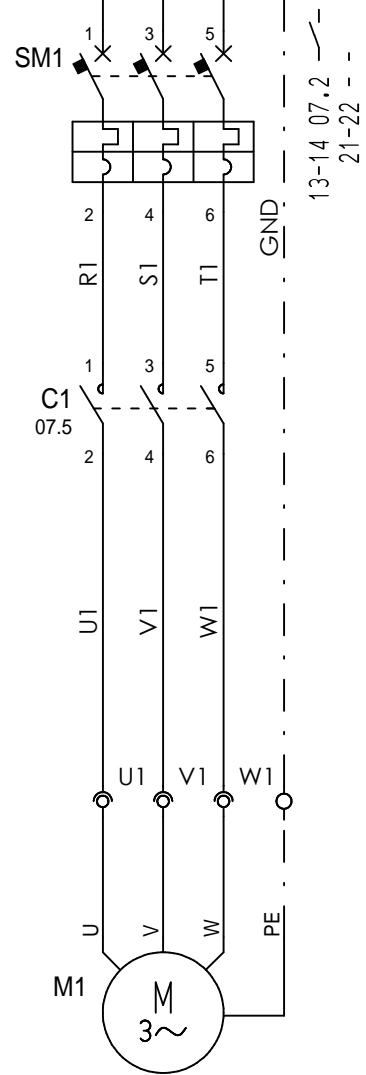

RACK

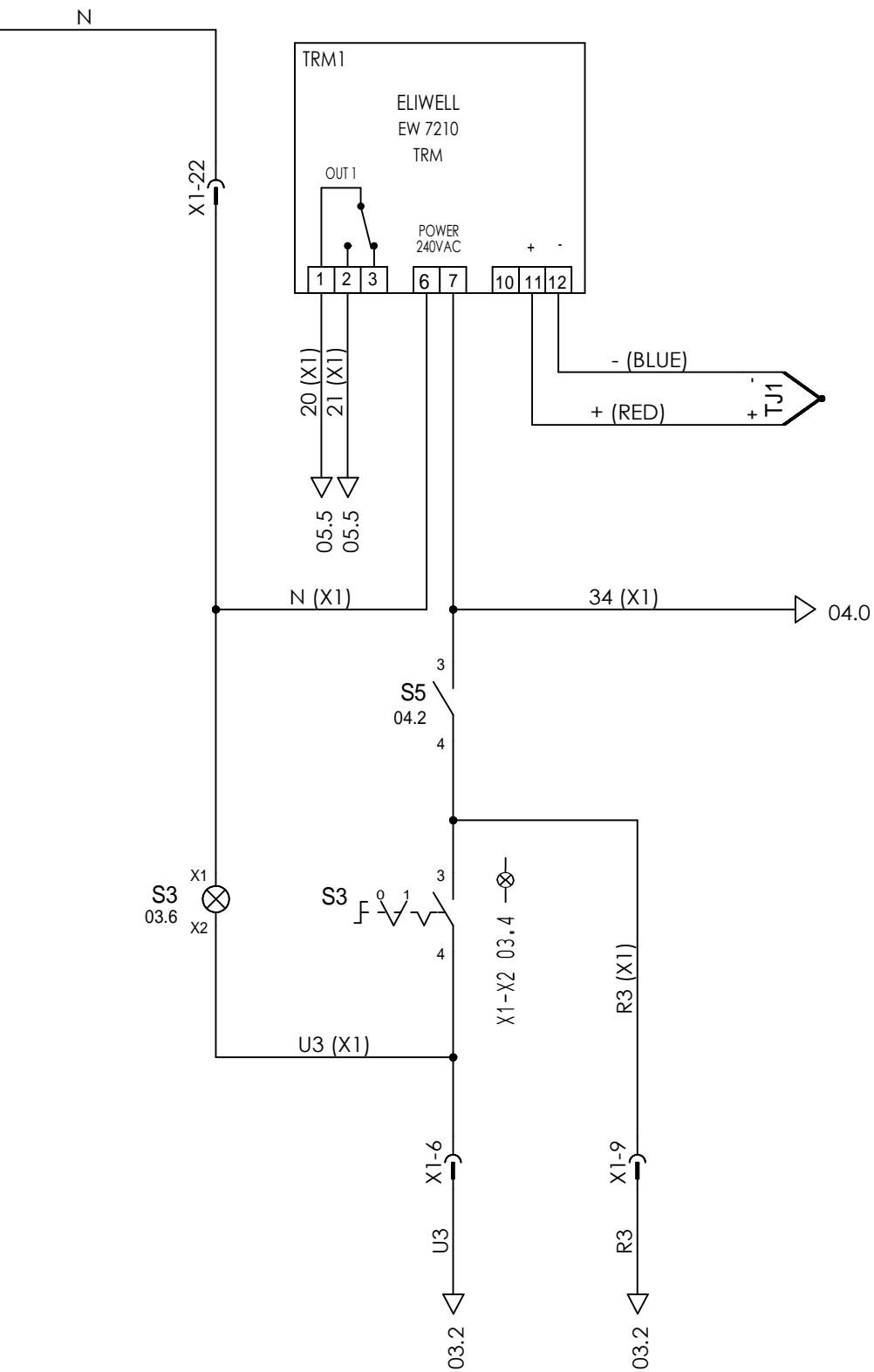
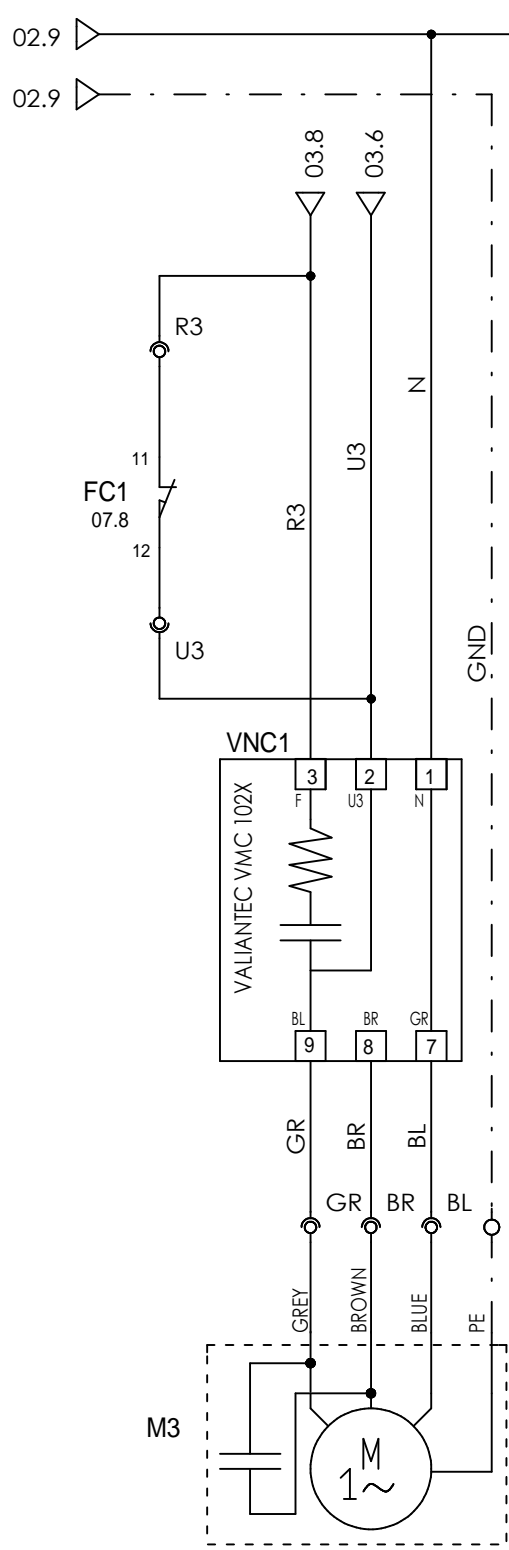
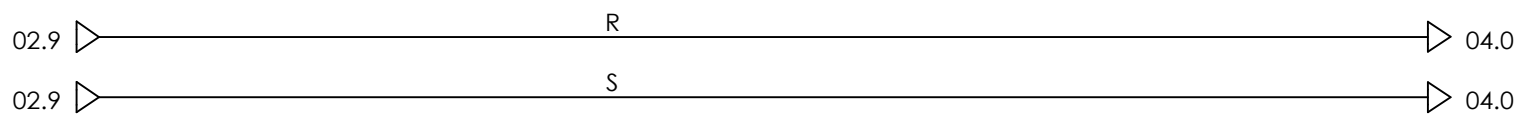

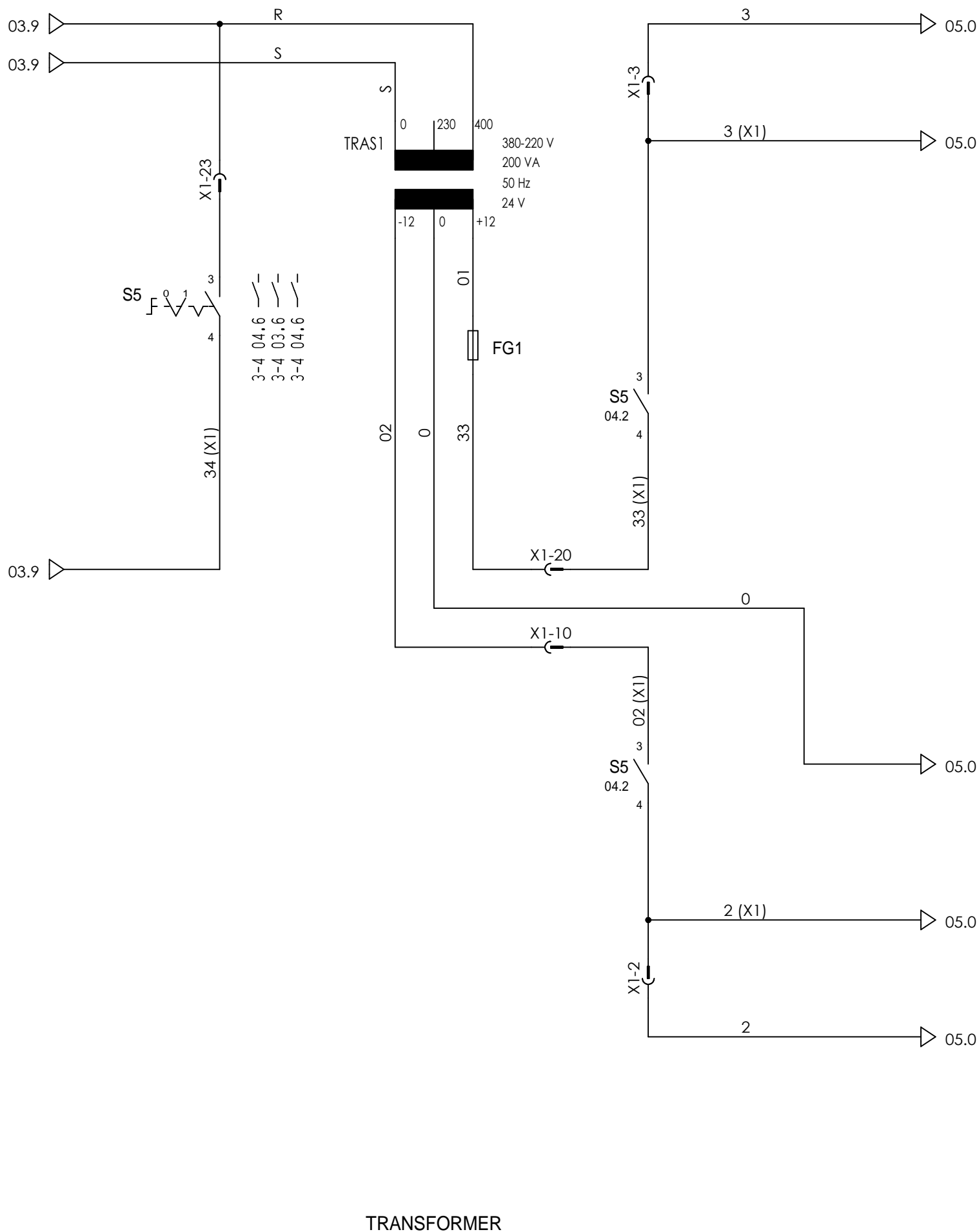

TRANSFORMER

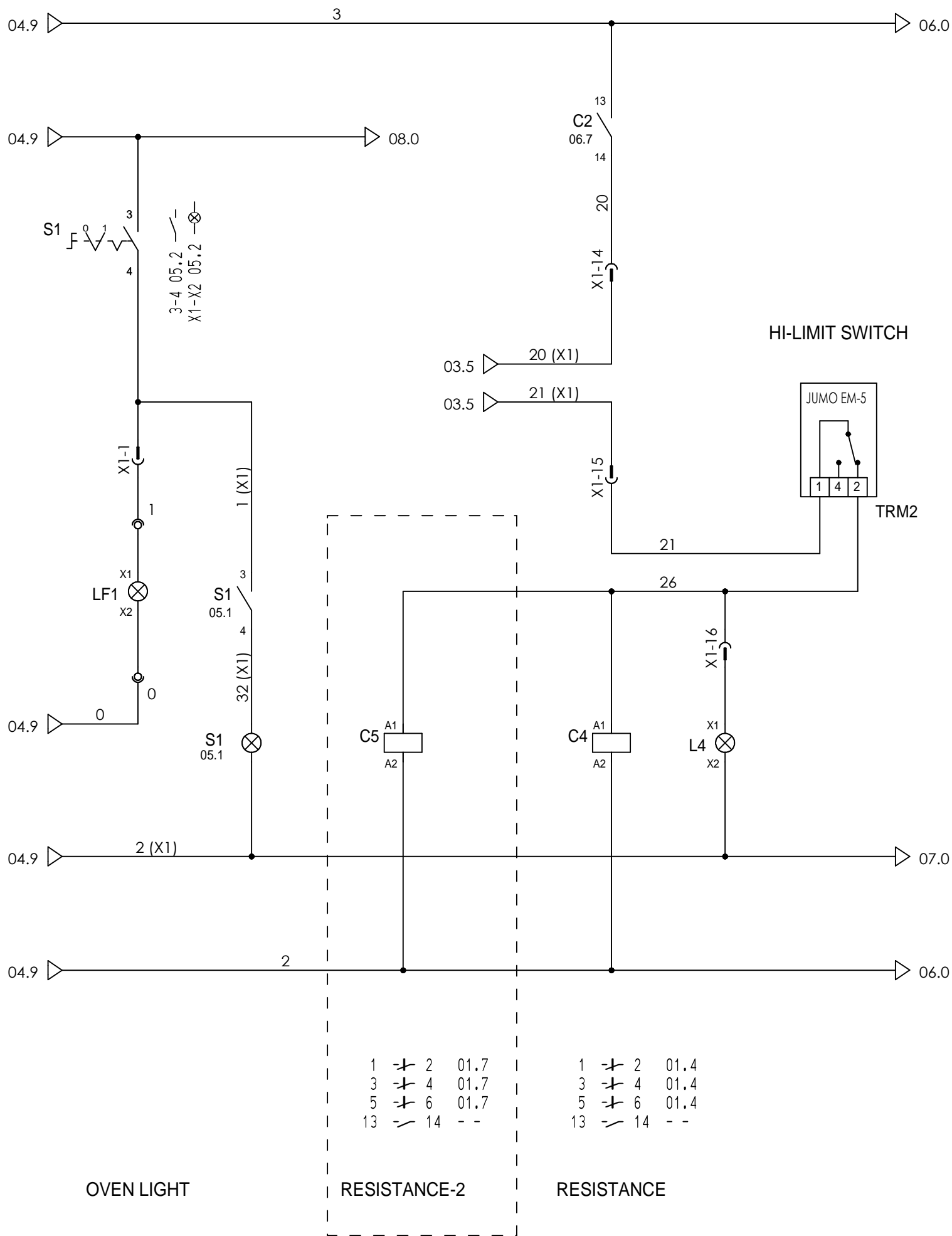

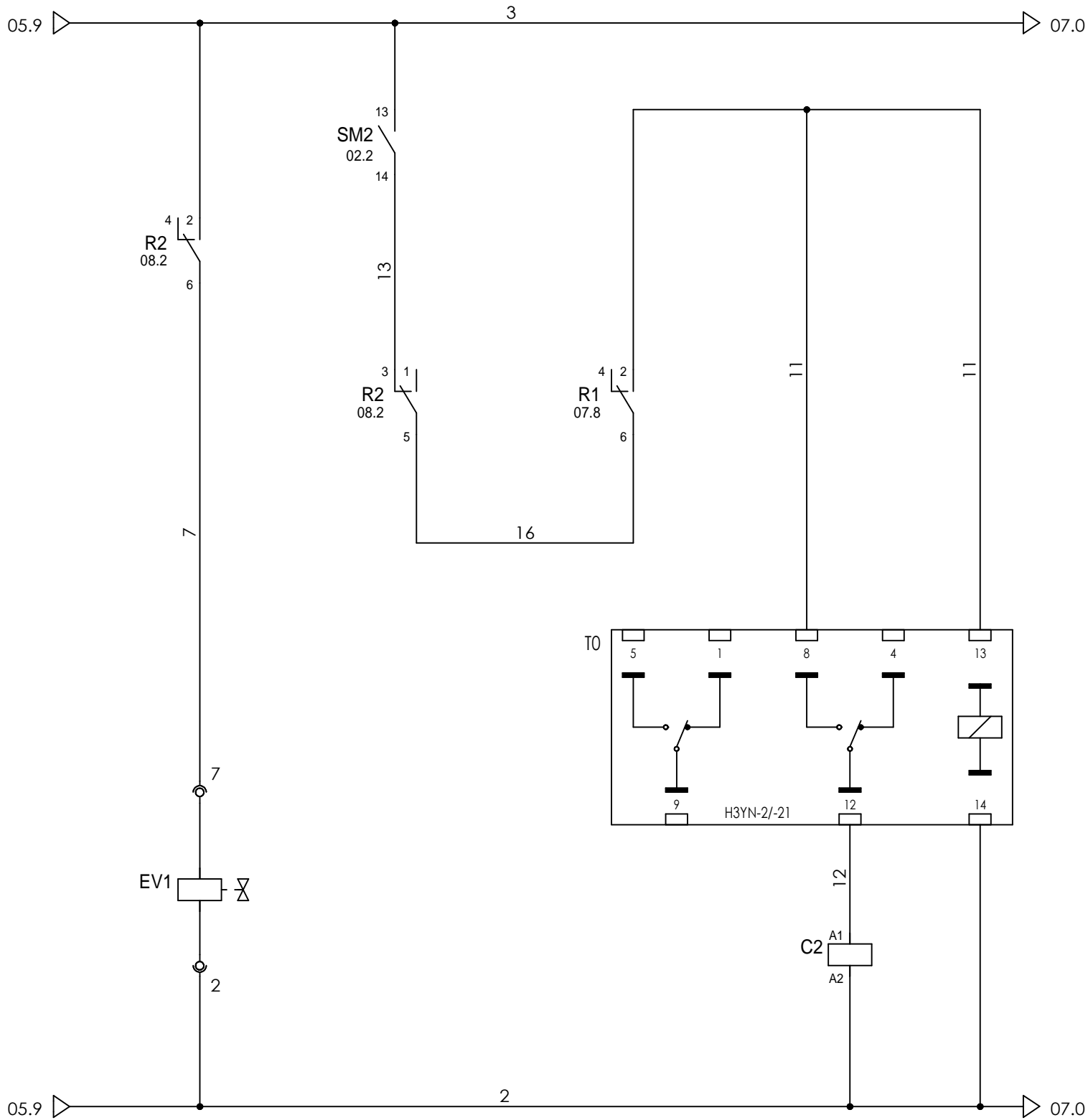

- 1 — 2 02.2
- 3 — 4 02.2
- 5 — 6 02.2
- 13 — 14 05.6 —

STEAM SOLENOID VALVE

BLOWER

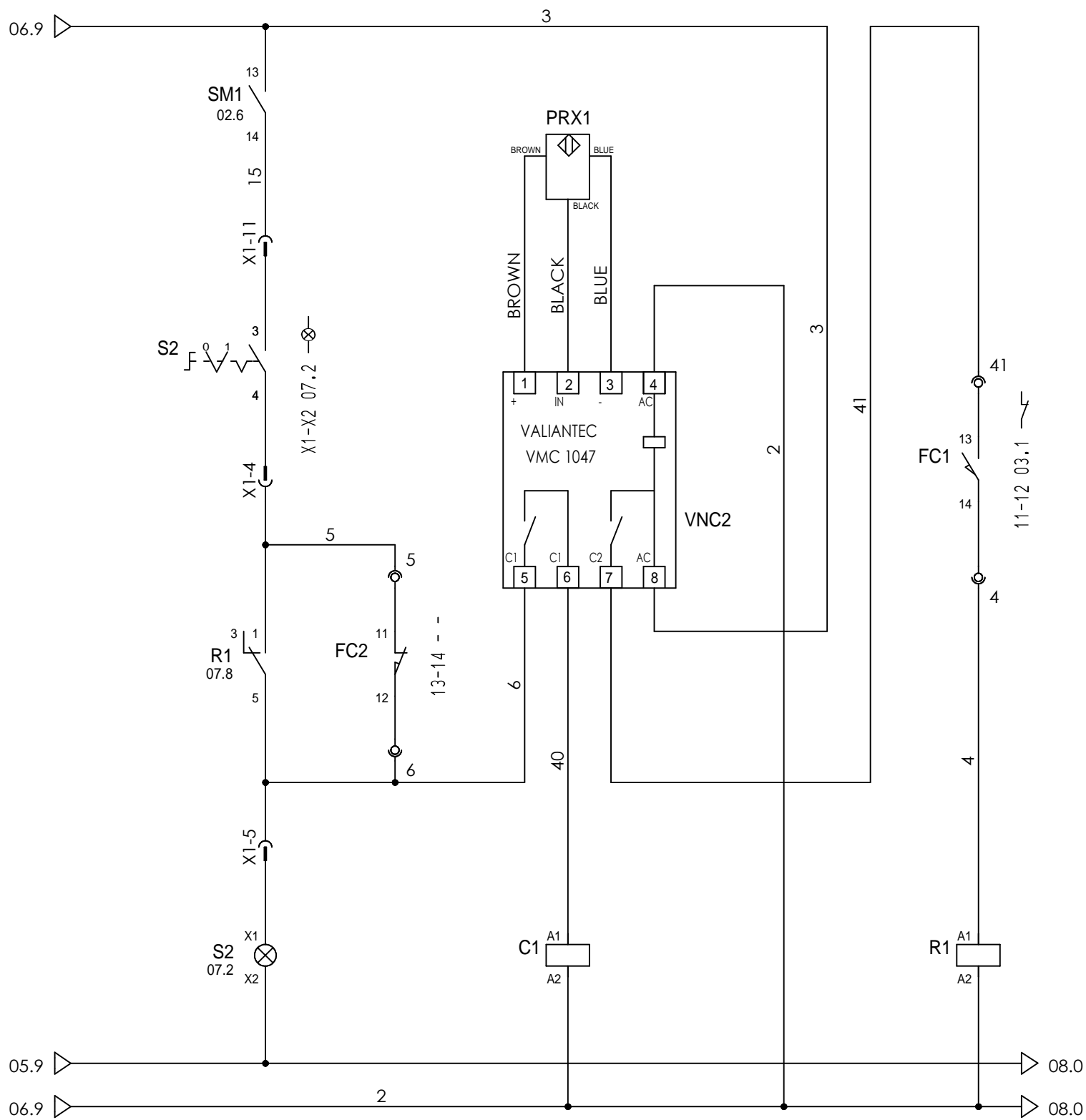

- | | | | |
|----|---|----|------|
| 1 | + | 2 | 02.6 |
| 3 | + | 4 | 02.6 |
| 5 | + | 6 | 02.6 |
| 13 | - | 14 | - - |

- | | | | | |
|---|---|---|---|------|
| 3 | 1 | + | 5 | 07.2 |
| 4 | 2 | + | 6 | 06.5 |

RACK ROTATION

DOOR RELAY

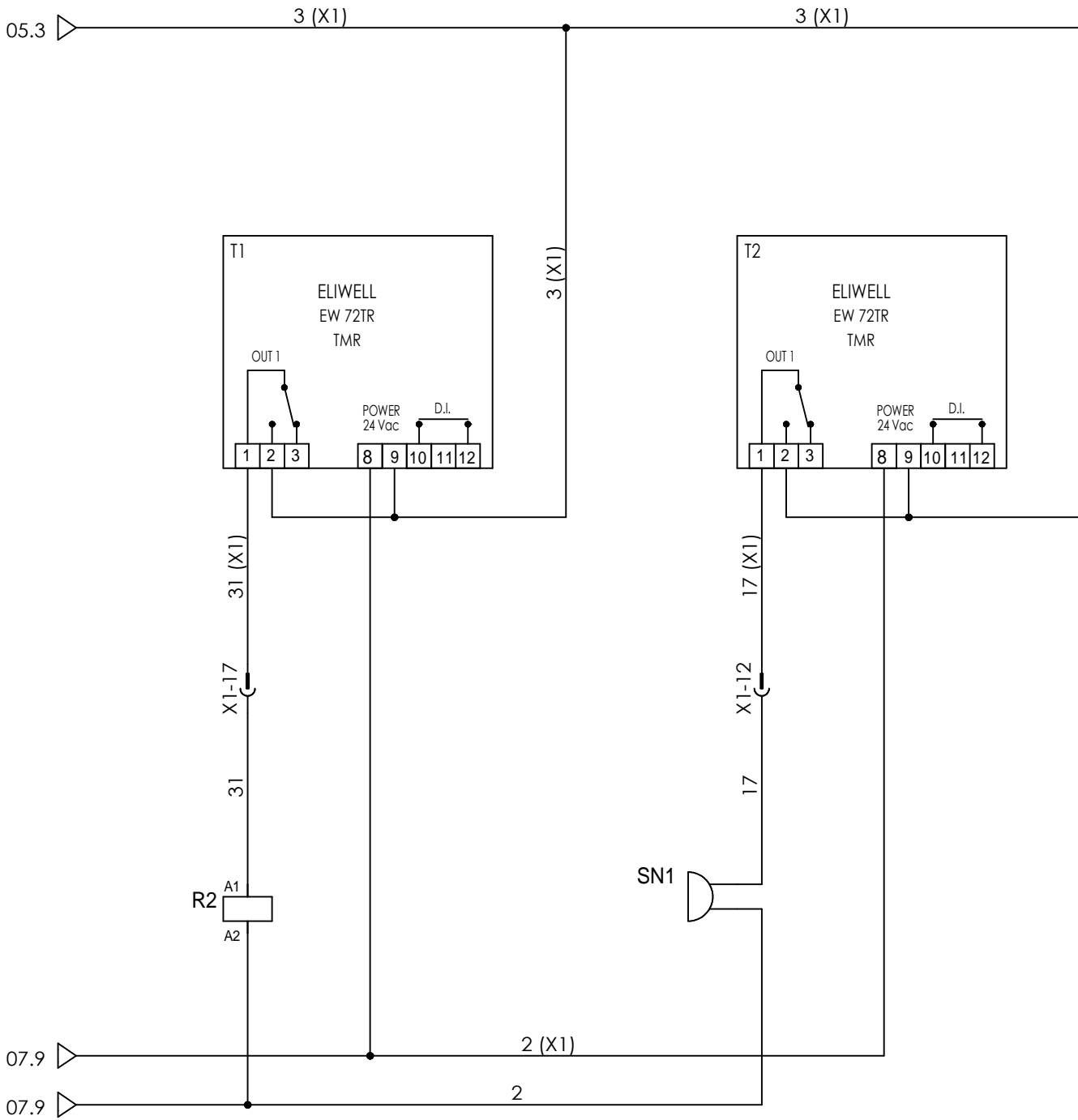

3 1 5 06.3
 4 2 6 06.1

STEAM

BAKING END BUZZER

CONNECTOR

X1

WIRE	TERMINALS	POSITION
------	-----------	----------

N° PIN : 24
PRODUCER : ILME

LIST LOCATIONS	
BM	ON UNIT
CP	POWER BOX
QC	CONTROL PANEL

COLUMN PAGE

1	1	1	05
02	10	5	04
3	3	6	04
5	4	2	07
6	5	2	07
U3	6	6	03
7		RESERVE	
8		RESERVE	
R3	9	8	03
2	2	6	04
15	11	2	07
17	12	6	08
13		RESERVE	
20	14	6	05
21	15	6	05
26	16	7	05
31	17	2	08
18		RESERVE	
19		RESERVE	
33	20	5	04
21		RESERVE	
N	22	4	03
R	23	2	04
24		RESERVE	

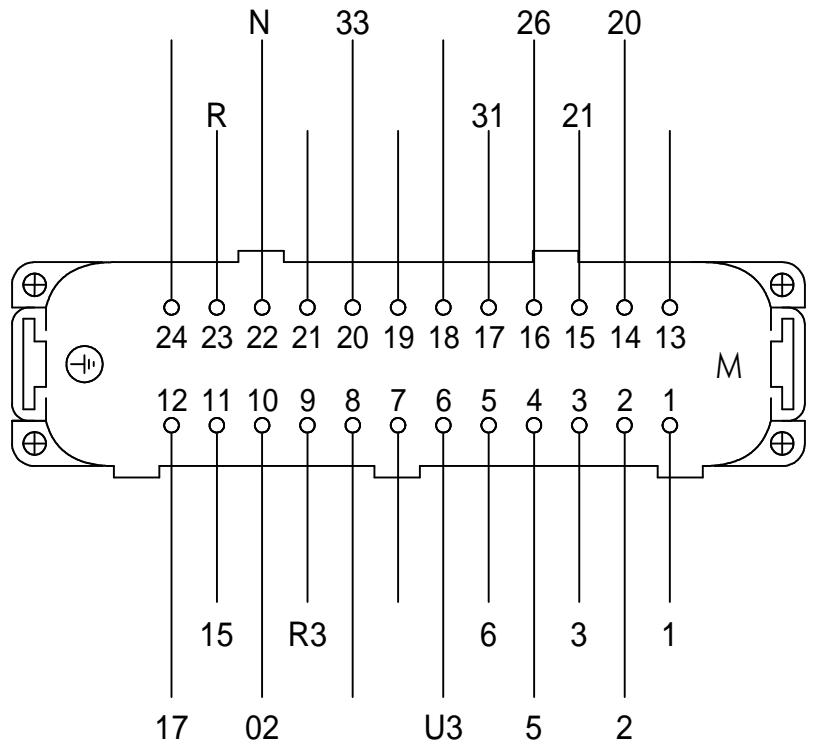

USAGE SUMMARY

Y1



POWER SUPPLIER

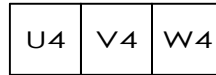

RESISTANCE

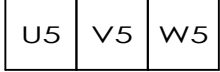

RESISTANCE-2

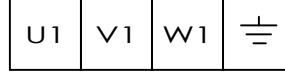

RACK ROTATION

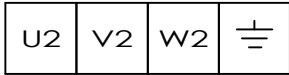

BLOWER MOTOR



STEAM SUCTION FAN MOTOR

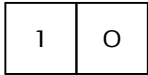

OVEN LIGHT

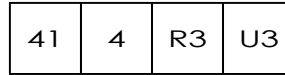

DOOR LIMIT SWITCH

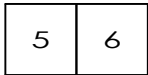

RACK LIMIT SWITCH

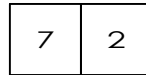

STEAM SOLENOID VALVE

PARTS LIST

code	DESCRIPTION	SPARE PART	LOCATION	PAGE
C1	RACK ROTATION MOTOR CONTACTOR	PRR 88	CP	07
C2	BLOWER MOTOR CONTACTOR	PRR 88	CP	06
C4	RESISTANCE CONTACTOR	PRR 87	CP	05
C5	RESISTANCE CONTACTOR-2	PRR 87	CP	05
EV1	STEAM SOLENOID VALVE	PRR 22	BM	06
FC1	DOOR LIMIT SWITCH	PRR 25	BM	07
FC2	RACK LIMIT SWITCH	PRR 25	BM	07
FG1	MAIN FUSE	PRR 27 - PRR 52/3	CP	04
FR1	RESISTANCE FUSES	PRR 29 - PRR 49/1	CP	01
FR2	RESISTANCE FUSES-2	PRR 29 - PRR 49/1	CP	01
IG1	MAIN SWITCH	PRR 31	CP	01
L4	PILOT LAMP RESISTANCE	PRR 74/1	QC	05
LF1	OVEN LIGHT	PRR 34/1	BM	05
M1	RACK ROTATION	PRR 40	BM	02
M2	BLOWER MOTOR	PRR 38	BM	02
M3	STEAM SUCTION FAN MOTOR	PRR 3/6	BM	03
PRX1	PROXIMITY	PRR 44/7	BM	07
R1	DOOR RELAY	PRR 61	CP	07
R2	STEAM RELAY	PRR 61	CP	08

PARTS LIST

code	DESCRIPTION	SPARE PART	LOCATION	PAGE
RES1	RESISTANCE	PRR 5	BM	01
RES2	RESISTANCE-2	PRR 5	BM	01
S1	OVEN LIGHT SELECTOR	PRR 69	QC	05
S2	RACK ROTATION SELECTOR	PRR 69	QC	07
S3	STEAM SUCTION FAN SELECTOR	PRR 69	QC	03
S5	MAIN SELECTOR	PRR 69	QC	04
SM1	AUTOMATIC SWITCH FOR RACK MOTOR	PRR 32	CP	02
SM2	AUTOMATIC SWITCH FOR FAN MOTOR	PRR 32	CP	02
SN1	BUZZER	PRR 75/1	CP	08
T0	BLOWER DELAY TIMER	PRR 90	CP	06
T1	HUMIDIFICATION TIMER	PRR 81	QC	08
T2	BAKING TIMER	PRR 81	QC	08
TJ1	TEMPERATURE PROBE FOR THERMOREGULATOR	PRR 72	BM	03
TRAS1	TRANSFORMER	PRR 86	CP	04
TRM1	THERMOREGULATOR	PRR 79	QC	03
TRM2	HI-LIMIT SWITCH	PRR 78	CP	05
VNC1	MODULE - 2 SPEED	PRR 36/6	CP	03
VNC2	PROXIMITY RELAY	PRR 61/5	QC	07

Power board

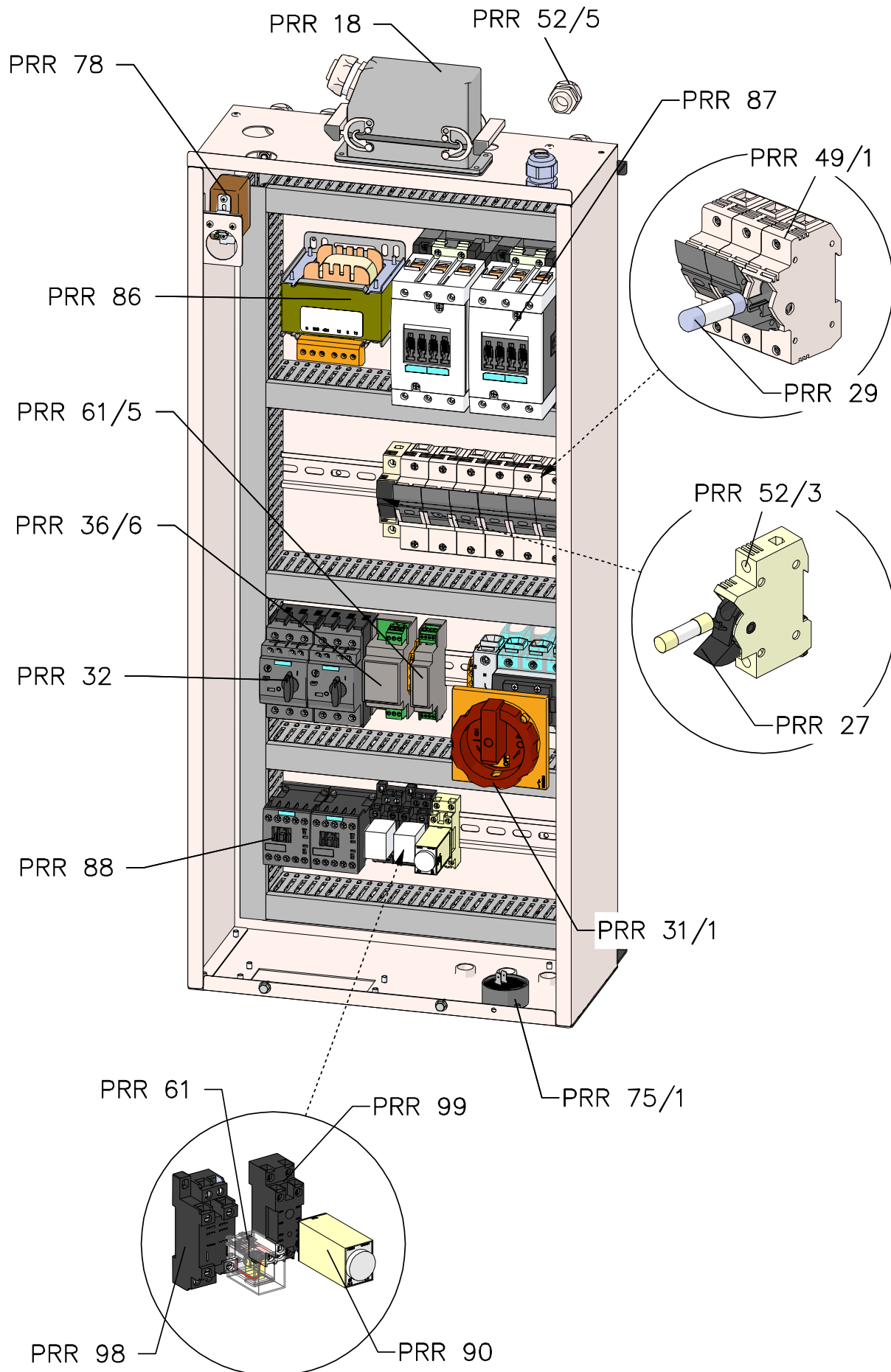

PRR 53/8

code

PRR 18	Electric board connector completed
PRR 27	Standard fuse
PRR 31/1	Mains switch for electric rotary ovens
PRR 52/3	Standard fuse holder (single-polar)
PRR 52/5	Straight sheath through
PRR 52/7	Curved sheath through
PRR 61	Relay
PRR 75/1	Two-sound electronic beeper
PRR 78	Max temp. thermostat
PRR 86	200VA transformer
PRR 88	Normal remote-control switch
PRR 90	Omron H3Y timer
PRR 98	Base for relay
PRR 99	Base for Omron H3Y
PRR 32	Automatic Switch
PRR 36/6	Interface For Steam Suction Fan - Single Phase
PRR 61/5	Relay For Proximity
PRR 29	Fuse for electric rotary ovens
PRR 49/1	Fuse holder for electric rotary ovens (tripolar)
PRR 87	Remote-control switch for electric rotary ovens

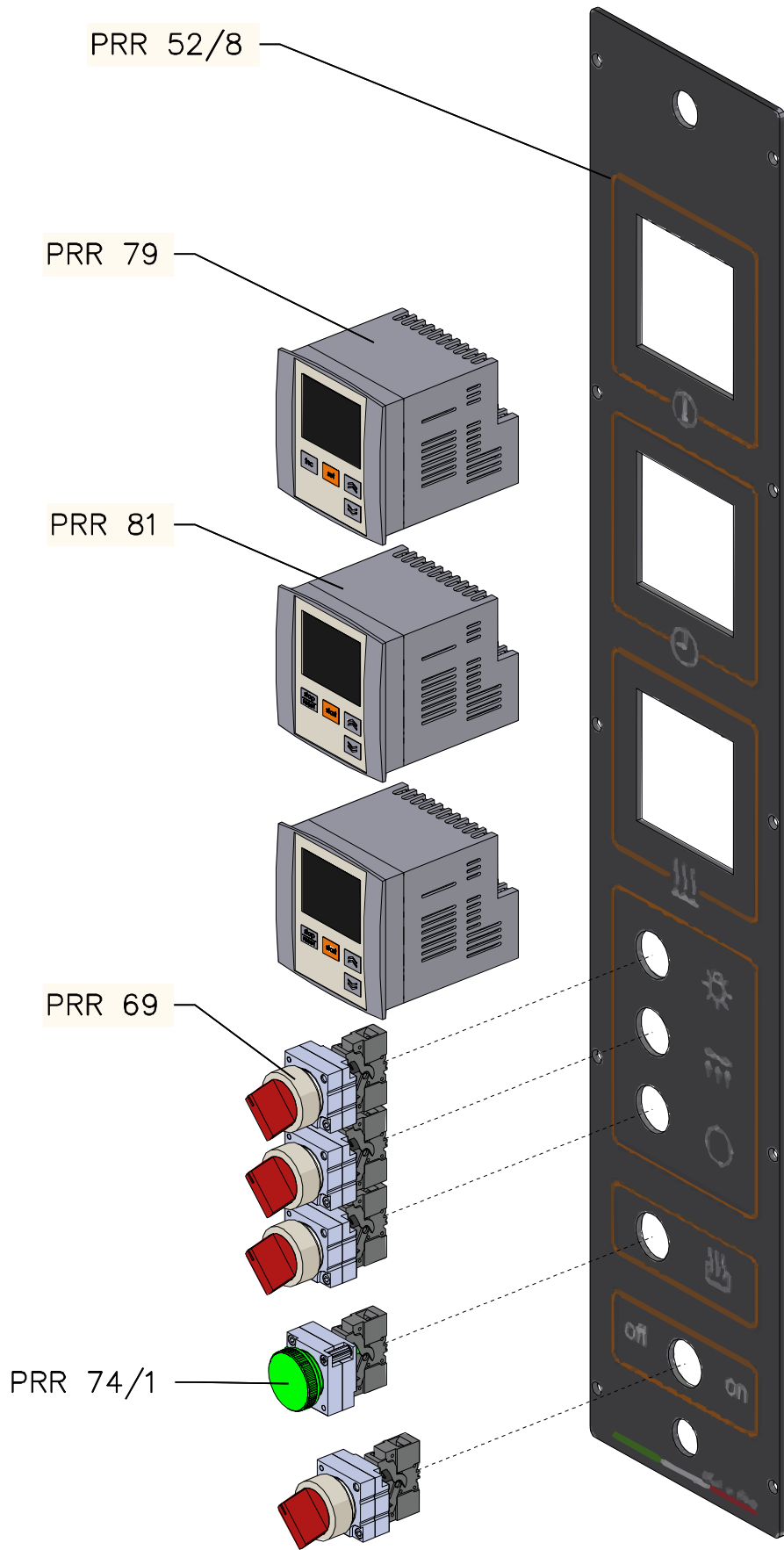

code

PRR 52/8	Electromechanical tool holder
PRR 79	ELIWELL electronic thermal adjuster
PRR 81	ELIWELL electronic timer
PRR 69	Switch
PRR 74/1	Green warning light
PRR 72	Probe for thermal adjuster